

8OWUD)DVW 5HFRYHU\ 'LRGHV \$)5

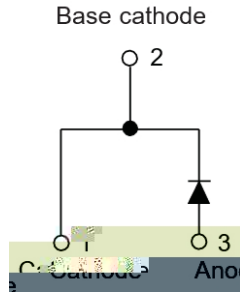

)HDWXUHV
 " +LJK IUHTXHQF\ RSHUDWLRQ
 " +LJK VXUJH IRUZDUG FXUUHQW FDSDELOLW
 " +LJK SXULW\ KLJK WHPSHUDWXUH HSR[\ H
 HQKDQFHG PHFKDQDQOPRWWVMXUWKJHVLVW

'DWD 0HFKDQLFDO
 " 3DFNDJH2 \$&
 0ROGLQJ FRPSR\QG PHH\WPPDELOLW\
 UDWLQJ 5R+6 FRPSOLDQW
 " 7HUPLQDQVSODWHG OHDGV VROGHUDEOH S
 DQG -(6' %
 " 3RODU\$WPDUNHG

V0D[LPXP 5DWMQJV8QOHVV RWKHU\LVH VSHFLILHG

3\$5\$(7(5	6<0%2,	81,7	085 3
'HYLFH PDUNLQJ FRGH			085 3
5HSHWLWLYH 3HDN 5HYHUVH 9RQW 9550		9	
\$YHUDJH 5HFWLILHG 2XWSXW &XUHQW # ZDYH 5 ORDG 7F),*		+] KDOI VLQH	
6XUJH 1RQ UHSHWLWLYH)RUZDUG &XUHQW # VLQH ZDYH MF\FOH 7		+] KDOI	
&XUHQW 6TXDUHG 7LPH #-PV"W	PVW7M	\$ V	
6LQJOH 3XOVH \$YDODQFKH (QHUJ\ # 7S 7M - / P+	(\$6	X6 P-	
6WRUDJH 7HPSHUDWXUH	7VWJ	-	a
-XQFWLRQ 7HPSHUDWXUH	7M	-	a
7\SLFDO -XQFWLRQ FDSDFLWDQFH # 8M0+] S)			



v(OHFWULFDO & KDU DFWHULSLW DQV FRWKHU ALVH VSHFLILHG

3\$5\$0(7(5	6<0%2/	81,7	7(67 & 21',7,216	0LQ	7\ S	0D[
LQVWDQWDQHRXV IRUZDUG YROWDJH GUROS SHU GLRGH	9)0		7M -			
'& UHYHUVH FXUUHQW DW UDWHG '& EORFNLQJ YROWDJH SHU GLRGH	.550		950 9550 7 -			
	.550		950 9550 7M -			
5HYHUVH 5HFRYHU\ 7LPH		QV	7M -			
			7M -			
3HDN UHFRYHU\ FXUUHQW 550		\$	7M -	\$	\$ XV	
			7M -	GL GW 950 9		
5HYHUVH UHFRYHU\ FKDUJH		Q &	7M - 4UU 7M -			

v7KHUPDO & KDUDFWHULSLW DQV FRWKHU ALVH VSHFLILHG

3\$5\$0(7(5	6<0%2/	81,7	085 3
7KHUPDO 5HVLVWDQGHZHHQ MXQFWLRQ DQG FDVH			- :

v2UGHULQJ , QIRUPDORQ

35() (5(' 3 1	81,7 : (* +7 J	0,1,,080 3\$&.\$*(SFV	,11(5 %2; 48\$17,7< SF	287(5 & \$572 48\$17,7< SF	'(/,9(5< 02' (
\$ 085 3	\$SSUR[LPDWH				7XEH

v& KDUDFWHULSLW DQV

\$YHUDJH)RUZDUG 2XWSXW & XUHH

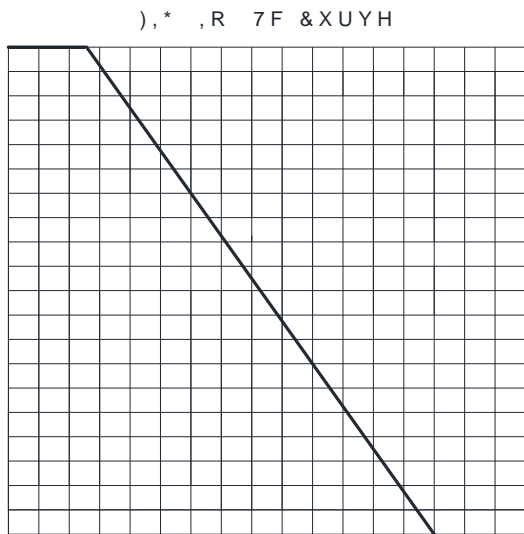

\$3HDN)RUZDUG 6XUJH & XUHHQW

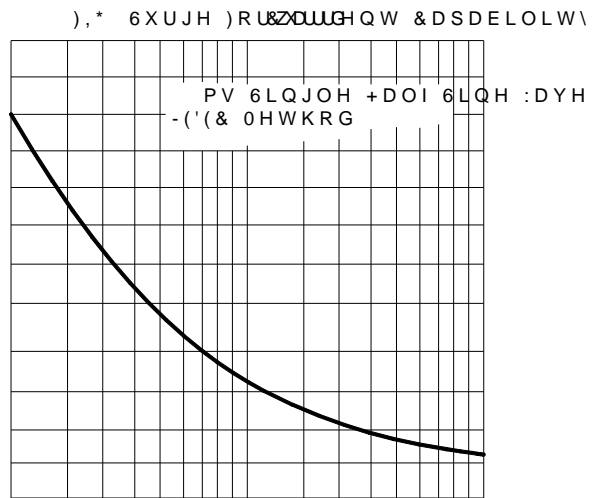

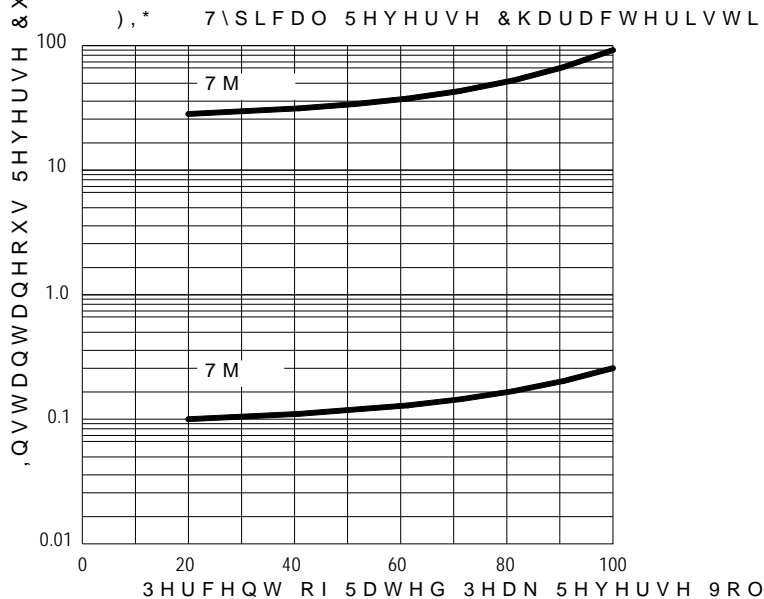
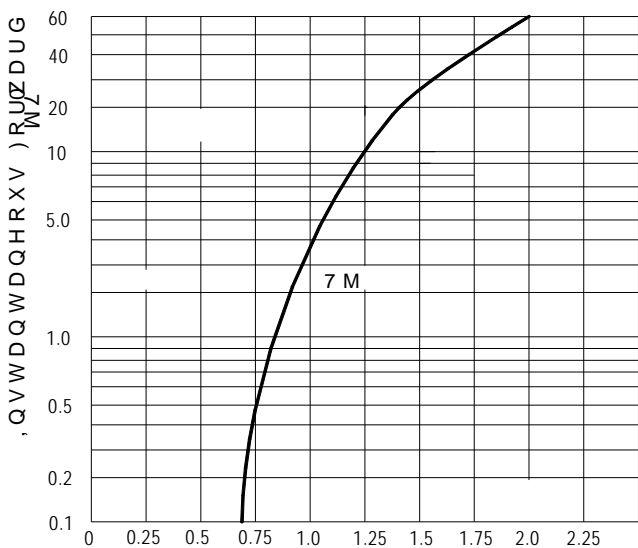

), * 'LDJUDP RI FLUFMLQJZDQY HHRUP RYHBYMLVPH UHFR

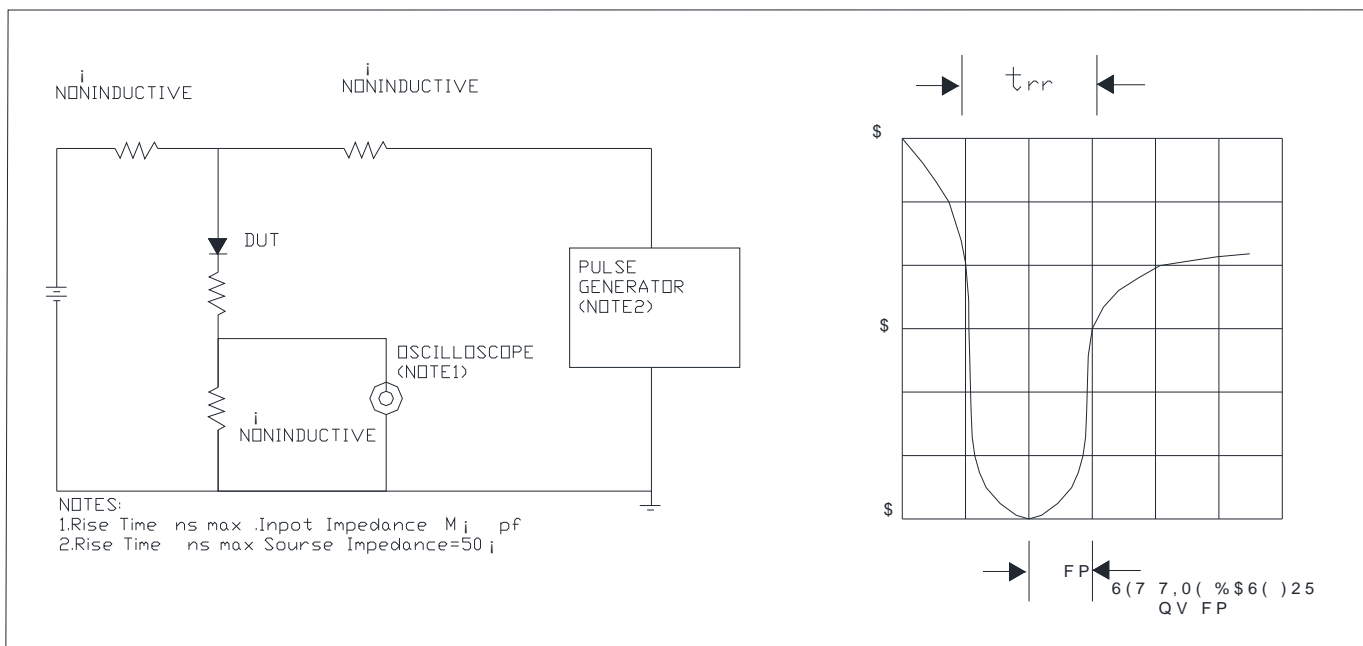

v2XWOLQH 'LPHQVLRQV

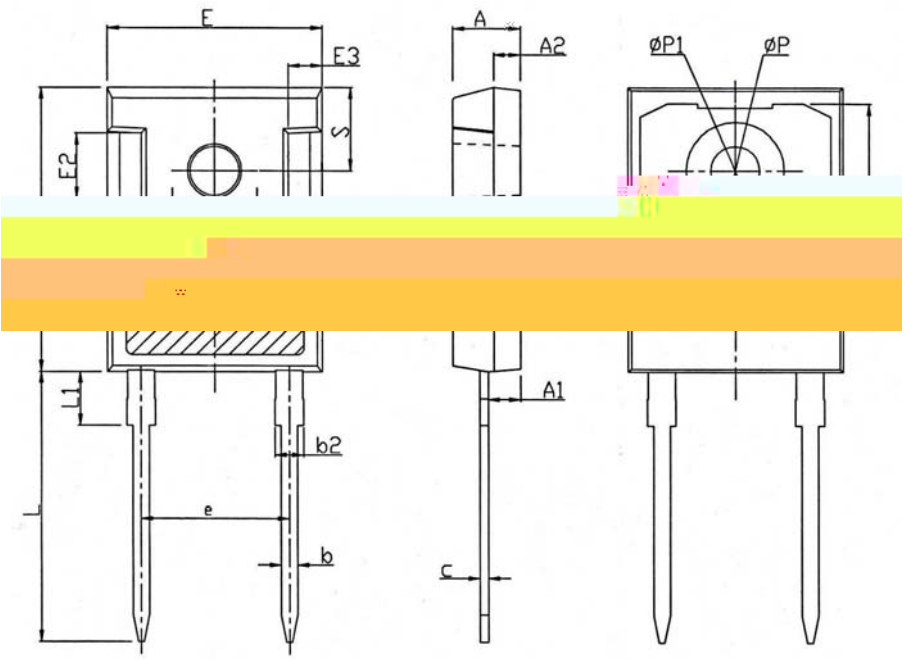

72 \$ &		
'LP	0LQ	0D
\$		
\$		
\$		
E		
E		
F		
'		
'		
(
(
(
(
H	% 6 &	
/		
/		
¶ 3		
¶ 3		
6	% 6 &	



'LVFODLPHU

7KH LQIRUPDWLRQ V GHVFXQWQV LQ WKLV UDQGHU LKRXF HDROO OZH F(HOHFVRUR QLF /VHG UHV
ULJKW WR PDNLWKRDXW LKRXVLSH FIRU RLVSLRQG R FWWV GLV SPSDURYGHKUHUGILDEWQGLV L JQQ F
RU RWKHUZLVH

7KH SURGXFWQLVGHV LKRXVLSH WR EH HXWVHGZLWQK R HGHQSDPHQW RU GHYLFHWWKQGG Q
HTXLSPHQW RU GHYLFHV ZKLFK UHTXLW KHKE DIO IZLWVQL RQXIDHGGDDEHGHVWQK DQFKQDOLIH
PHGLFDO LQVWUXQMSRUWHDQWL RQHUTXLSH H RQFKOHU U UHDFWRHU FFRQWURROOHV DQ
GHYLFHV <DQJMLHVRV DQKQ H DQVXRQV VQRWUHQVSRQVLEWV R O VDIQ JGIDRQJMMFK LP
RI VDOH

7KLV SXEOLFDFWRQ SVXSSHUW DGHV LQURQVXLSRQ LSGHYRUR XGGLWLRQDO LQWRUPDWLR
KWV ESZ \DQJMLHRFRFRQVXOW \RXU QHDUHVW <DQJMLHVRV DQVLEWV RILFH IRU IXUW